

**MAJORETTE**

**CREATIX** 



***Creatix Rescue Station***

***21 205 0015***

# MAJORETTE

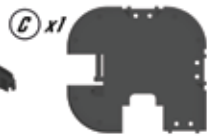

(D) x1

(E) x1

(F) x1

(G) x1

(H) x6

(I) x1

(J) x1

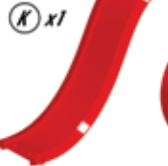

(M) x1

(N) x1



(S) x1

(U) x3

(W) x1

(K) x1

(L) x1

(N) x1

(P) x1

(S) x1

(U) x3

(W) x1



(Y) x1

(Z) x1

(AA) x1

(BB) x1

(CC) x1

(DD) x1

(EE) x1

(FF) x2

(GG) x3

(HH) x1

(II) x1

(JJ) x1

(KK) x3

FLASH CODE

For assembly video, please scan here



[www.majorette.com/en/videos/](http://www.majorette.com/en/videos/)

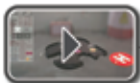



2

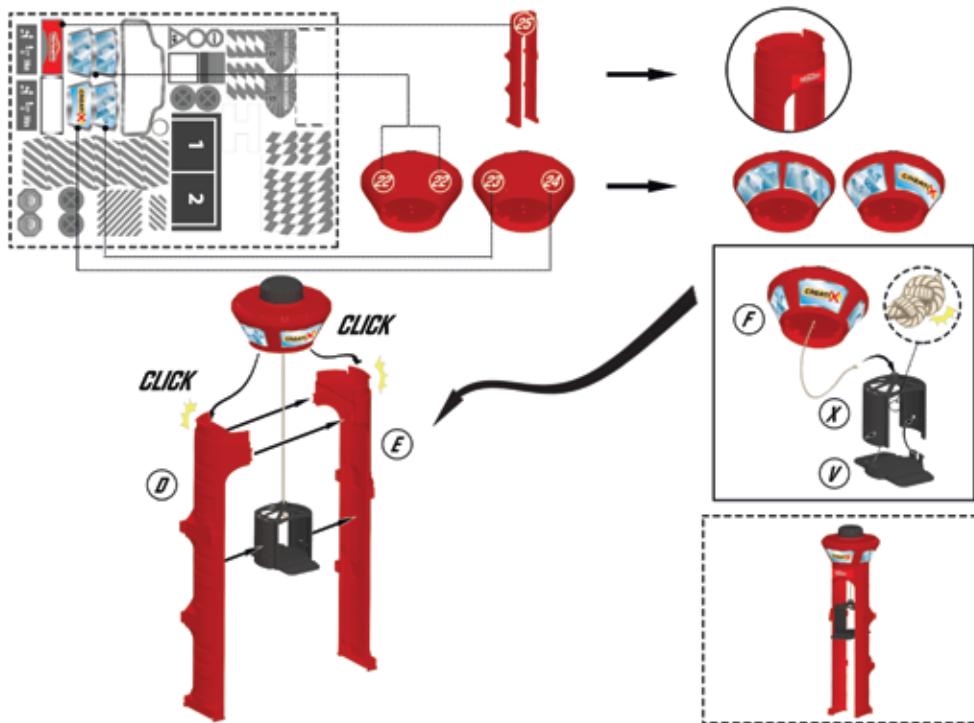

**3**

4

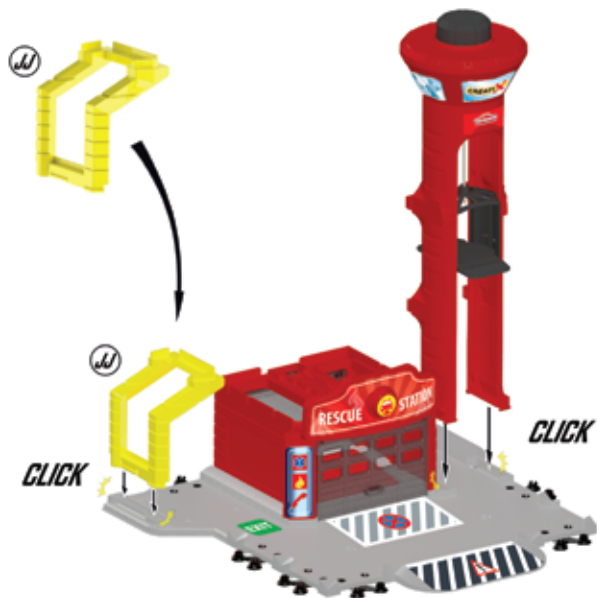

5

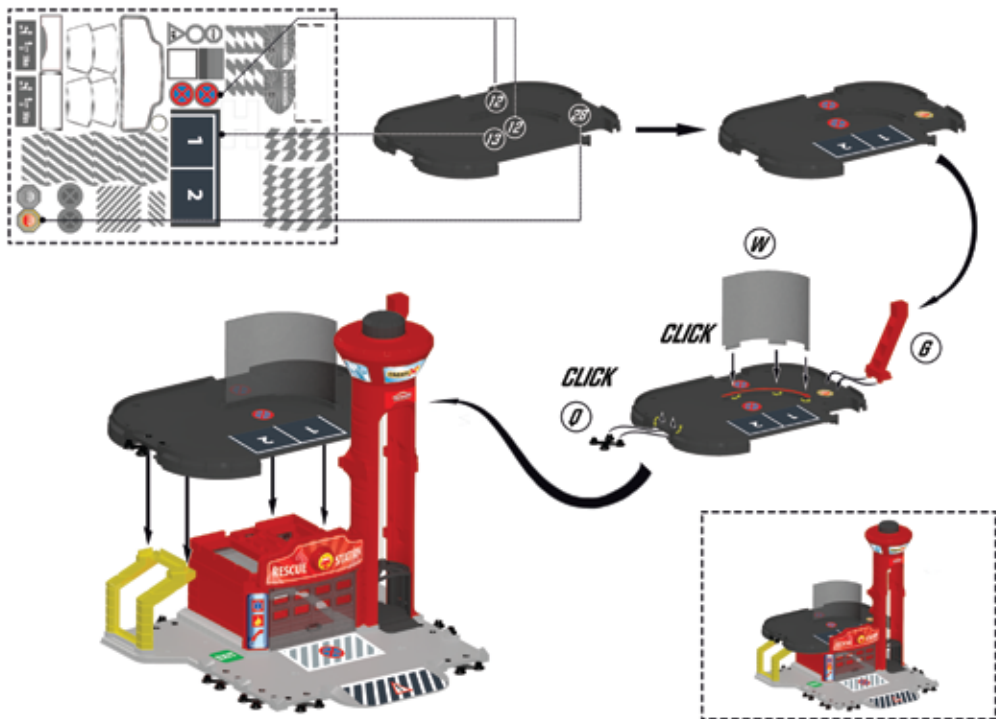

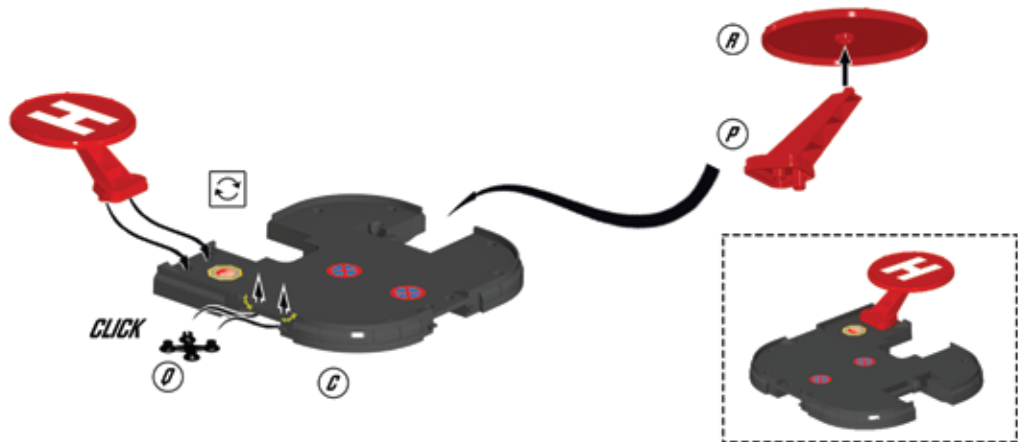
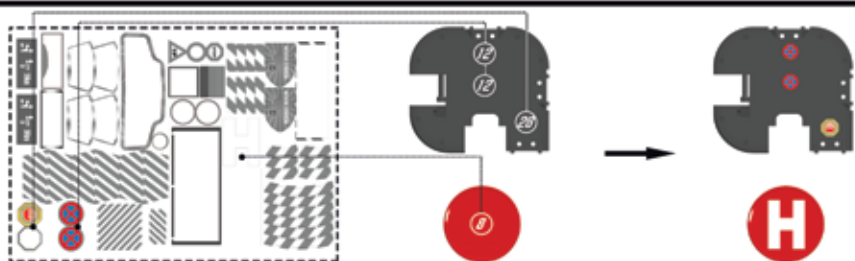
**6**



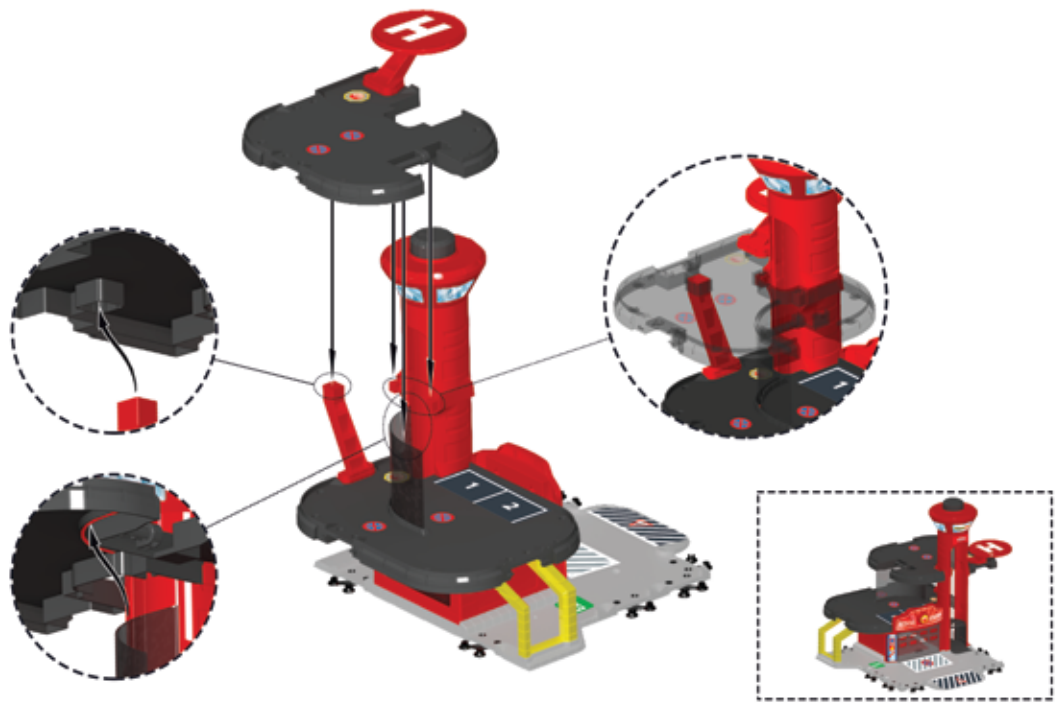

7

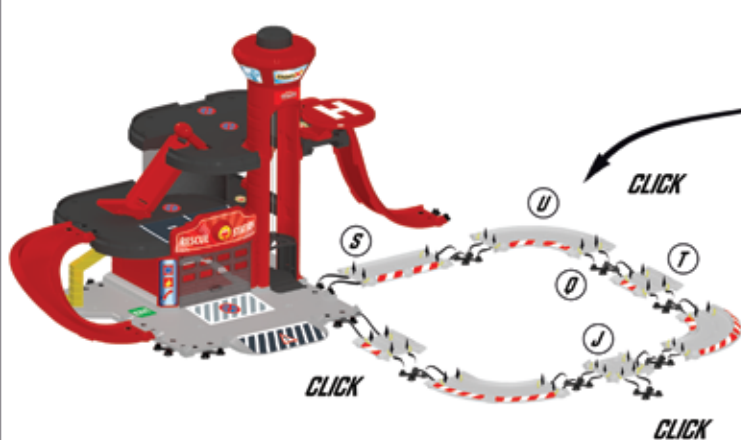
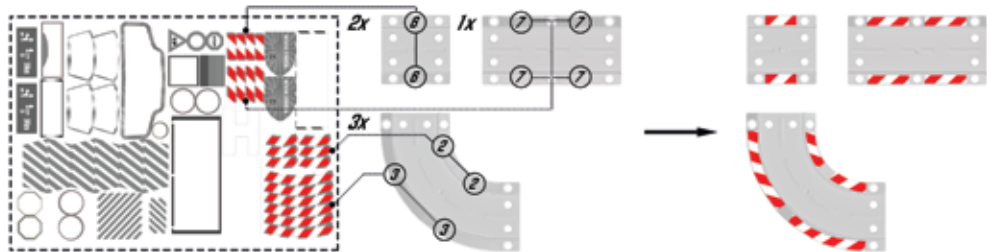

**8**

**9**

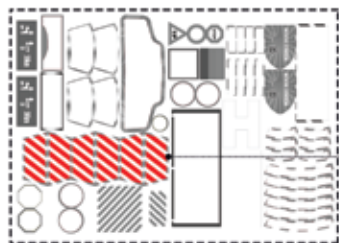

*5x*

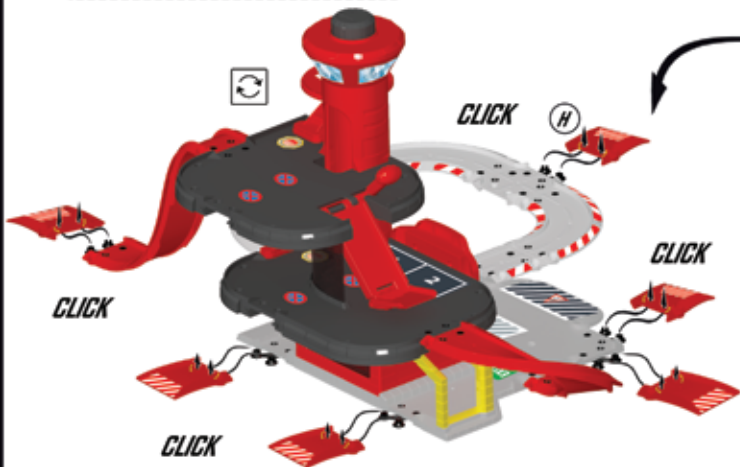
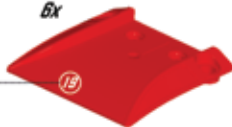

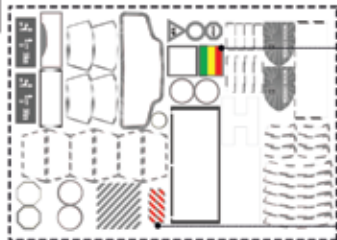
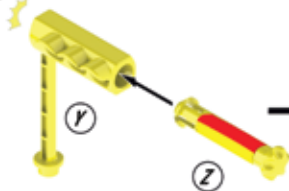
**10****CLICK****CLICK**

11

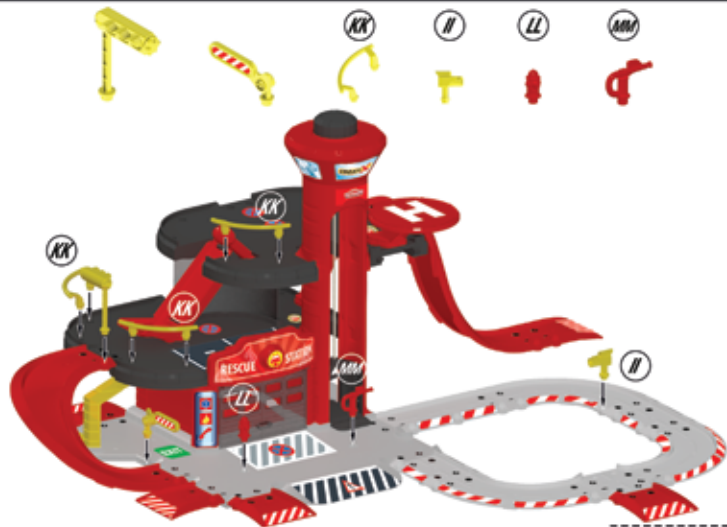

12

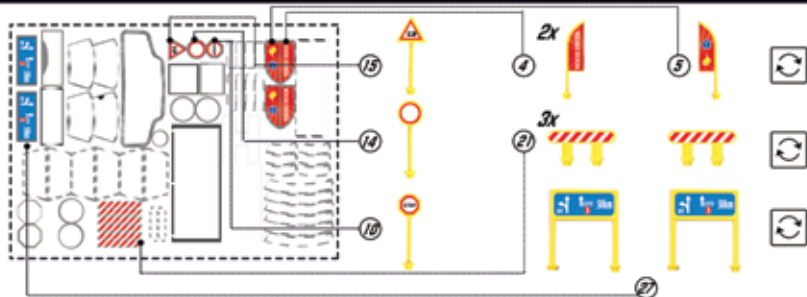

- DE: Service:**  
Sollte der Artikel Funktionsstörungen aufweisen, wenden Sie sich bitte vertrauensvoll an die Verkaufsstelle, in der Sie das Spielzeug erworben haben. Falls Ihnen dort nicht weiter geholfen werden kann, nutzen Sie bitte unseren Service im Internet unter <http://www.majorette.com/de/kontakt/>
- GB: Service:**  
If the product malfunctions, please do not hesitate to contact the sales outlet where you bought the toy. If they are unable to help you, please use our Internet service at <http://www.majorette.com/en/contact/>
- FR: SAV :**  
En cas de dysfonctionnement de l'article, veuillez vous adresser au point de vente où vous avez acheté le jouet.  
Si aucune aide ne peut vous être apportée, veuillez recourir à notre service après-vente sur Internet à <http://www.majorette.com/fr/contact/>
- NL: Service:**  
Indien het artikel functiestoornissen vertoont kunt u het beste contact opnemen met het verkooppunt, waar u het speelgoed heeft gekocht.  
Als men u daar niet verder kan helpen, gebruik a.u.b. onze Internet service op <http://www.majorette.com/en/contact/>
- I: Service:**  
Qualora il prodotto dovesse presentare malfunzionamenti, Vi preghiamo di rivolgervi con fiducia al punto vendita in cui avete acquistato il giocattolo.  
Se lì non fosse possibile esservi d'aiuto, Vi preghiamo di utilizzare il nostro servizio d'assistenza internet sul sito <http://www.majorette.com/en/contact/>
- ES: Servicio:**  
Si el artículo presentara un funcionamiento anómalo, diríjase con total confianza al punto de venta donde ha adquirido el juguete.  
En caso de que allí no se le pueda ayudar, utilice nuestro servicio postventa de Internet en <http://www.majorette.com/es/contact/>
- P: Assistência técnica:**  
Se este artigo apresentar problemas de funcionamento, não hesite em dirigir-se à loja onde adquiriu o brinquedo.  
Caso não o possamos ajudar, utilize o nosso serviço de assistência técnica na Internet, em <http://www.majorette.com/en/contact/>
- S: Service:**  
Vänd er till försäljningsstället där ni köpt leksaken, om artikeln inte fungerar störningsfritt. Om man inte kan hjälpa er där, rekommenderar vi vår Internet-service under <http://www.majorette.com/en/contact/>
- N: Service:**  
Dersom denne artikkelen skulle påvise funksjonsfeil, så vennligst henvende deg til forretningen der du har kjøpt leketøyet.  
Dersom man ikke skulle være i stand til å hjelpe deg der, så vennligst bruk vår service i internett under <http://www.majorette.com/en/contact/>
- DK: Service:**  
Skulle artiklen udvise funktionsfejl, bedes du henvende dig til forretningen, hvor du har købt legetøjet. Kan man ikke hjælpe dig der, bedes du benytte vores internet-service på <http://www.majorette.com/en/contact/>
- FIN: Huolto:**  
Jos tuotteen esinyt toimintahäiriöitä, käänny luottamuksella leikkikalun myyneen myyntipisteen puoleen.  
Jos sinua ei voida siellä auttaa, käytä palveluamme Internetissä osoitteessa <http://www.majorette.com/en/contact/>
- TR: Service:**  
Eğer ürün işlev arzaları gösterirse, güvenerек оуuncagi satın aldığınız satış noktasına başvurabilirsiniz. Ancak, ilgili yerden hizmet alamıyorsanız o zaman <http://www.majorette.com/en/contact/> / Internet sayfasındaki servis bölümünden faydalanabilirsiniz.
- GR: Σέρβις:**  
Σε περίπτωση που το προϊόν παρουσιάσει διαταραχές λειτουργίας, παρακαλούμε να απευθυνθείτε στο κατάστημα, όπου αγοράσατε το παιχνίδι.  
Εάν δεν είναι εκείνη η περίπτωση, τότε παρακαλούμε να χρησιμοποιήσετε το Σέρβις μας στη διαδικτυακή πύλη <http://www.majorette.com/en/contact/>
- BG: Сервис:**  
Ако при този артикул се установи повреда във функцията, Вие може да се обърнете поверително към магазина, където сте закупили играчката.  
Ако там не могат да Ви помогнат, използвайте нашия сервис в интернет на <http://www.majorette.com/en/contact/>
- CZ: Servis:**  
Pokud by výrobek vykazoval funkční vadu, obraťte se prosím s důvěrou na prodejnu, v níž jste hračku koupili. Pokud Vám zde nedokážou pomoci, využijte náš servis na internetu na adrese <http://www.majorette.com/en/contact/>
- H: Ügyfélszolgálat:**  
Amennyiben a cikknek működési zavarai lennének, bízalommal forduljon ahhoz az üzlethez, ahol megvette a játékot. Abban az esetben, ha ott nem tudnak segíteni Önnek, az internet szolgálatásainkat szíveskedjen igénybe venni a következő link alatt: <http://www.majorette.com/en/contact/>
- HRV: Servis:**  
Ako bi artikl imao funkcijske smetnje, obratite se molimo Vas s puno povjerenja Vašoj trgovini, u kojoj ste kupili igračku. Ako Vam tamo ne budu dalje pomogli, koristite naš servis u Internetu pod <http://www.majorette.com/en/contact/>
- PL: Serwis:**  
Jeśli zabawka nie działa prawidłowo, proszę skontaktować się ze sklepem, w którym ją zakupiono. W razie gdy nie uzyskają tam Państwo pomocy, proszę skorzystać z naszego portalu serwisowego w internecie pod <http://www.majorette.com/en/contact/>
- RO: Service:**  
În cazul în care articolul manifestă deranjamente de funcționare, vă rugăm să vă adresați cu încredere unității comerciale în care ați cumpărat jucăria.  
În cazul în care nu vi se poate da ajutor acolo, vă rugăm să folosiți service-ul nostru din internet la adresa <http://www.majorette.com/en/contact/>
- RUS: Сервис:**  
При выявлении неисправностей в изделии, уверенно обращайтесь в торговое предприятие, где вы приобрели игрушку.  
В случае, если и там Вам не смогут помочь, воспользуйтесь нашим сервисом в интернете по адресу <http://www.majorette.com/en/contact/>
- SK: Servis:**  
Keby výrobok vykazoval funkčné poruchy, obráťte sa bez obáv na predajňu, v ktorej ste hračku kúpili. Ak vám nedokážu pomôcť, využite náš internetový servis na adrese <http://www.majorette.com/en/contact/>
- SI: Podpora:**  
Če izdelek ne deluje pravilno, se obrnite na trgovino, kjer ste igračo kupili.  
Če vam tam ne morejo pomagati, obiščite našo podporo na internetu na <http://www.majorette.com/en/contact/>
- UA: Сервіс:**  
При виявленні несправностей у виробі, впевнено звертайтеся до торгового підприємства, де Ви придбали іграшку. У випадку, якщо і там Вам не зможуть допомогти, скористайтеся з нашого сервісу в інтернеті за адресою <http://www.majorette.com/en/contact/>